

5

- Press ▲/MAX until the meter displays the thermocouple type:

Your choices are J, K, T, E, N, DNJ, R, S, and B.

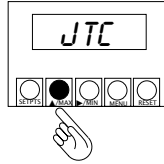

- Press MENU. The meter displays:

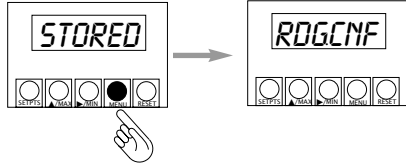

- Press RESET twice. The meter displays:

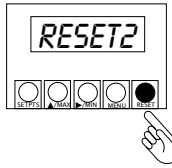

and then shows the current temperature.

To Set Temperature Units:

- Press MENU until the meter displays:

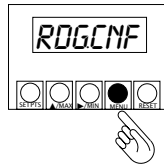

- Press ►/MIN until the meter displays:

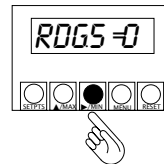

- Press ▲/MAX to change the value.

Your choices are:
0 = °C, 1 = °F, 2 = °K

- Press MENU to enter the value. The meter displays:

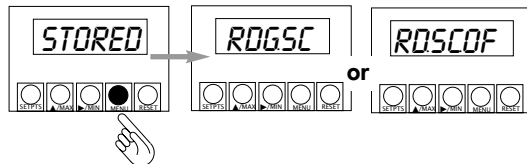

6

- Press RESET twice. The meter displays:

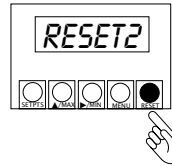

and then shows the current temperature.

To Set Decimal Point Position:

- Press MENU until the meter displays:

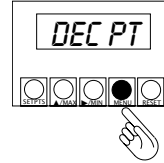

- Press ▲/MAX to move the decimal point to the desired location.

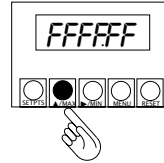

- Press MENU. The meter displays:

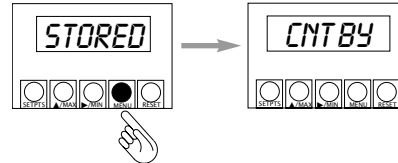

- Press RESET twice. The meter displays:

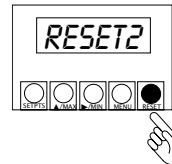

and then shows the current temperature.

The unit is now up and running.

WARNING: These products are not designed for use in, and should not be used for, patient connected applications.

This device is marked with the international caution symbol. It is important to read the Setup Guide before installing or commissioning this device as it contains important information relating to safety and EMC.

It is the policy of NEWPORT to comply with all worldwide safety and EMC/EMI regulations that apply. NEWPORT is constantly pursuing certification of its products to the European New Approach Directives. NEWPORT will add the CE mark to every appropriate device upon certification.

The information contained in this document is believed to be correct, but NEWPORT Electronics, Inc. accepts no liability for any errors it contains, and reserves the right to alter specifications without notice.

TRADEMARK NOTICE:

NEWPORT, **NEWPORT**, newportUS.com, **INFINITY**, and **INFINITY**, and the "Meter Bezel Design" are trademarks of NEWPORT Electronics, Inc.

Warranty/Disclaimer

NEWPORT Electronics, Inc. warrants this unit to be free of defects in materials and workmanship for a period of one (1) year from the date of purchase. In addition to NEWPORT's standard warranty period, NEWPORT Electronics will extend the warranty period for one (1) additional year if the warranty card enclosed with each instrument is returned to NEWPORT.

If the unit should malfunction, it must be returned to the factory for evaluation. NEWPORT's Customer Service Department will issue an Authorized Return (AR) number immediately upon phone or written request. Upon examination by NEWPORT, if the unit is found to be defective it will be repaired or replaced at no charge. NEWPORT's WARRANTY does not apply to defects resulting from any action of the purchaser, including but not limited to mishandling, improper interfacing, operation outside of design limits, improper repair, or unauthorized modification. This WARRANTY is VOID if the unit shows evidence of having been tampered with or shows evidence of being damaged as a result of excessive corrosion; or current, heat, moisture or vibration; improper specification; misapplication; misuse or other operating conditions outside of NEWPORT's control. Components which wear are not warranted, including but not limited to contact points, fuses, and triacs.

NEWPORT is pleased to offer suggestions on the use of its various products. However, NEWPORT neither assumes responsibility for any omissions or errors nor assumes liability for any damages that result from the use of its products in accordance with information provided by NEWPORT, either verbal or written. NEWPORT warrants only that the parts manufactured by it will be as specified and free of defects. NEWPORT MAKES NO OTHER WARRANTIES OR REPRESENTATIONS OF ANY KIND WHATSOEVER, EXPRESSED OR IMPLIED, EXCEPT THAT OF TITLE, AND ALL IMPLIED WARRANTIES INCLUDING ANY WARRANTY OF MERCHANTABILITY AND FITNESS FOR A PARTICULAR PURPOSE ARE HEREBY DISCLAIMED. LIMITATION OF LIABILITY: The remedies of purchaser set forth herein are exclusive and the total liability of NEWPORT with respect to this order, whether based on contract, warranty, negligence, indemnification, strict liability or otherwise, shall not exceed the purchase price of the component upon which liability is based. In no event shall NEWPORT be liable for consequential, incidental or special damages.

CONDITIONS: Equipment sold by NEWPORT is not intended to be used, nor shall it be used: (1) as a "Basic Component" under 10 CFR 21 (NRC), used in or with any nuclear installation or activity; or (2) in medical applications or used on humans. Should any Product(s) be used in or with any nuclear installation or activity, medical application, or used on humans, or misused in any way, NEWPORT assumes no responsibility as set forth in our basic WARRANTY / DISCLAIMER language, and additionally purchaser will indemnify NEWPORT and hold NEWPORT harmless from any liability or damage whatsoever arising out of the use of the Product(s) in such a manner.

Return Requests/Inquiries

Direct all warranty and repair requests/inquiries to the NEWPORT Customer Service Department. BEFORE RETURNING ANY PRODUCT(S) TO NEWPORT, PURCHASER MUST OBTAIN AN AUTHORIZED RETURN (AR) NUMBER FROM NEWPORT'S CUSTOMER SERVICE DEPARTMENT (IN ORDER TO AVOID PROCESSING DELAYS). The assigned AR number should then be marked on the outside of the return package and on any correspondence.

The purchaser is responsible for shipping charges, freight, insurance and proper packaging to prevent breakage in transit.

FOR WARRANTY RETURNS, please have the following information available BEFORE contacting NEWPORT:

- P.O. number under which the product was PURCHASED,
- Model and serial number of the product under warranty, and
- Repair instructions and/or specific problems relative to the product.

FOR NON-WARRANTY REPAIRS, consult NEWPORT for current repair charges. Have the following information available BEFORE contacting NEWPORT:

- P.O. number to cover the COST of the repair,
- Model and serial number of product, and
- Repair instructions and/or specific problems relative to the product.

NEWPORT's policy is to make running changes, not model changes, whenever an improvement is possible. This affords our customers the latest in technology and engineering.

NEWPORT is a registered trademark of NEWPORT Electronics, Inc.

© Copyright 2002 NEWPORT Electronics, Inc. All rights reserved.

This document may not be copied, photocopied, reproduced, translated, or reduced to any electronic medium or machine-readable form, in whole or in part, without prior written consent of NEWPORT Electronics, Inc.

PATENT NOTICE: This product is covered by one or more of the following patents: U.S. Pat. No. Des. 336,895; 5,274,577 / CANADA 2052599; 2052600 / ITALY 1249456; 1250938 / FRANCE BREVET No. 91 12756 / SPAIN 2039150; 2048066 / UK PATENT No. GB2 249 837; GB2 248 954 / GERMANY DE 41 34398 C2. OTHER INTERNATIONAL PATENTS PENDING.

QUICK START



INFT (Thermocouple) High Performance Temperature Indicator



THE NEW STANDARD FOR QUALITY

For immediate technical or application assistance please call:

1-800-6397678
1-800-NEWPORT

Newport Electronics, Inc.
2229 South Yale Street • Santa Ana, CA • 92704 • U.S.A.
TEL: (714) 540-4914 • FAX: (714) 546-3022
Toll Free: 1-800-639-7678 • <http://www.newportUS.com> • e-mail: info@newportUS.com
ISO 9001 Certified

Newport Technologies, Inc.
976 Bergar • Laval (Quebec) • H7L 5A1 • Canada
TEL: (514) 335-3183 • FAX: (514) 856-8886
Toll Free: 1-800-639-7678 • <http://www.newport.ca> • e-mail: sales@newport.ca

Newport Electronics, Ltd.
One Omega Drive • River Bend Technology Centre
Northbank, Irlam • Manchester M44 5BD • United Kingdom
Tel: +44 161 777 6611 • FAX: +44 161 777 6622
Toll Free: 0800 488 488 • <http://www.newportuk.co.uk> • e-mail: sales@newportuk.co.uk

Newport Electronics B.V.
Postbus 8034 • 1180 LA Amstelveen • The Netherlands
TEL: +31 20 3472121 • FAX: +31 20 6434643
Toll Free: 0800 0993344 • <http://www.newport.nl> • e-mail: sales@newport.nl

Newport Electronics spol s.r.o.
Rudé armády 1868, 733 01 Karviná 8 • Czech Republic
TEL: +420 69 6311899 • FAX: +420 69 6311114
Toll Free: 0800-1-66342 • <http://www.newport.cz> • e-mail: sales@newport.cz

Newport Electronics GmbH
Daimlerstrasse 26 • D-75392 Deckenpfronn • Germany
TEL: 49 7056 9398-0 • FAX: 49 7056 9398-29
Toll Free: 0800 / 6397678 • <http://www.newport.de> • e-mail: sales@newport.de

Newport Electronique S.A.R.L.
9, rue Denis Papin • 78190 Trappes • France
TEL: +33 130 621 400 • FAX: +33 130 699 120
Toll Free: 0800-4-06342 • <http://www.newport.fr> • e-mail: sales@newport.fr

Mexico and Latin America
TEL: 001-800-826-6342 • FAX: 001 (203) 359-7807
En Español: 001 (203) 359-7803

NEWPORTnet™ On-Line Service www.newportUS.com **Internet e-mail** info@newportUS.com

NEWPORT Electronics, Inc.

START HERE

Using This Quick Start Manual

Use this Quick Start Manual to get your Temperature Indicator, when used with a Thermocouple, up and running right out of the box. To do this you:

- connect ac power
- connect the Thermocouple
- configure the unit
 - specify Thermocouple type
 - set degrees to C or F
 - set decimal point position

Before You Begin

You should have the following parts:

- Meter
- Front-panel button cover
- Panel-mounting gaskets
- ac Power Connector (orange -P1), Input Connectors (2) (grey -P3 and P9), and rear protective cover (mounted) with green Cold Junction Compensation Board (right side).

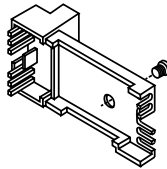

You **MUST** have this component.

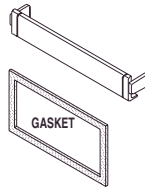

Contact the nearest Customer Service Department using the numbers listed on the front of this Quick Start manual if any parts are missing, or if you have questions.

In addition to the unit and related parts, you will need the following items to set up your unit:

- ac power, as listed on meter's Product/ID label
- Thermocouple
- 1/8" flat blade screwdriver
- 1/8" Phillips head screwdriver

2

Connect ac Power

1. Remove the rear protective cover and set it aside. The cover is secured with a Phillips-head screw.
2. Locate connector P1 on the bottom-left-rear of the unit. The connector has three screw-down terminals.
3. Insert the correct wire in each terminal and tighten the lockdown screw. Tug gently on each wire to verify the connection.

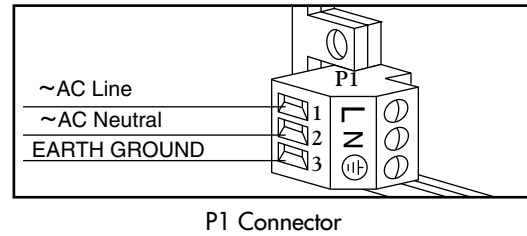

CAUTION

Take care not to damage the green Cold Junction Compensation Board and its connectors.

4. Replace the rear cover. Verify proper seating of the connectors on the green Cold Junction Compensation Board.
5. Thread the power wires through the slots on the side of the cover. Replace the rear cover retaining screw.

3

Connect the Thermocouple

NOTE

Regardless of thermocouple type, the RED wire is always **NEGATIVE**.

The cover on the thermocouple connector shows the positive and negative terminals.

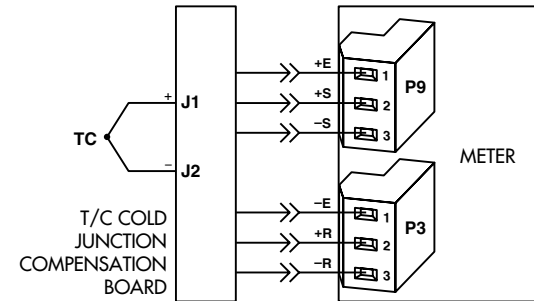

1. Attach the wires and tighten the retaining screws. Tug gently on each wire to verify the connection.
2. Apply ac power. The front panel of the unit displays *RESET?*, followed by the temperature. If it does not:
 - a. Remove ac power.
 - b. Verify your P1 power connections.
 - c. Check your power source.
 - d. Plug the unit in again.

If the unit flashes *+OPEN*, the Cold Junction Compensation Board is not seated properly. Check the connections and the rear cover retaining screw, and repeat this step.

4

Configure the Unit

Press the front panel buttons:

Press This Button: To:



access the configuration menus and move from one menu to the next.



enter and scroll through a submenu



change the value of a submenu



move backward one menu (press once) or exit the configuration menus (press twice).

To Set Thermocouple Type:

1. Press MENU until the meter displays:

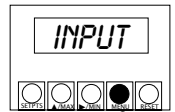

2. Press ▲/MAX until the meter flashes:

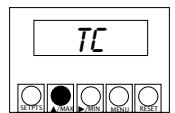

3. Press MENU until the meter displays:

