



## WARRANTY/DISCLAIMER

OMEGA ENGINEERING, INC. warrants this unit to be free of defects in materials and workmanship for a period of **25 months** from date of purchase of the **base unit** and **13 months** from date of purchase on **Laser Sight Module**. OMEGA's Warranty adds an additional one (1) month grace period to the normal **one (1) year product warranty** to cover handling and shipping time. This ensures that OMEGA's customers receive maximum coverage on each product.

If the unit malfunctions, it must be returned to the factory for evaluation. OMEGA's Customer Service Department will issue an Authorized Return (AR) number immediately upon phone or written request. Upon examination by OMEGA, if the unit is found to be defective, it will be repaired or replaced at no charge. OMEGA's WARRANTY does not apply to defects resulting from any action of the purchaser, including but not limited to mishandling, improper interfacing, operation outside of design limits, improper repair, or unauthorized modification. This WARRANTY is VOID if the unit shows evidence of having been tampered with or shows evidence of having been damaged as a result of excessive corrosion; or current, heat, moisture or vibration; improper specification; misapplication; misuse or other operating conditions outside of OMEGA's control. Components which wear are not warranted, including but not limited to contact points, fuses, and triacs.

**OMEGA is pleased to offer suggestions on the use of its various products. However, OMEGA neither assumes responsibility for any omissions or errors nor assumes liability for any damages that result from the use of its products in accordance with information provided by OMEGA, either verbal or written. OMEGA warrants only that the parts manufactured by it will be as specified and free of defects. OMEGA MAKES NO OTHER WARRANTIES OR REPRESENTATIONS OF ANY KIND WHATSOEVER, EXPRESS OR IMPLIED, EXCEPT THAT OF TITLE, AND ALL IMPLIED WARRANTIES INCLUDING ANY WARRANTY OF MERCHANTABILITY AND FITNESS FOR A PARTICULAR PURPOSE ARE HEREBY DISCLAIMED. LIMITATION OF LIABILITY: The remedies of purchaser set forth herein are exclusive, and the total liability of OMEGA with respect to this order, whether based on contract, warranty, negligence, indemnification, strict liability or otherwise, shall not exceed the purchase price of the component upon which liability is based. In no event shall OMEGA be liable for consequential, incidental or special damages.**

**CONDITIONS:** Equipment sold by OMEGA is not intended to be used, nor shall it be used: (1) as a "Basic Component" under 10 CFR 21 (NRC), used in or with any nuclear installation or activity; or (2) in medical applications or used on humans. Should any Product(s) be used in or with any nuclear installation or activity, medical application, used on humans, or misused in any way, OMEGA assumes no responsibility as set forth in our basic WARRANTY/DISCLAIMER language, and, additionally, purchaser will indemnify OMEGA and hold OMEGA harmless from any liability or damage whatsoever arising out of the use of the Product(s) in such a manner.

## RETURN REQUESTS/INQUIRIES

Direct all warranty and repair requests/inquiries to the OMEGA Customer Service Department. BEFORE RETURNING ANY PRODUCT(S) TO OMEGA, PURCHASER MUST OBTAIN AN AUTHORIZED RETURN (AR) NUMBER FROM OMEGA'S CUSTOMER SERVICE DEPARTMENT (IN ORDER TO AVOID PROCESSING DELAYS). The assigned AR number should then be marked on the outside of the return package and on any correspondence.

FOR **WARRANTY RETURNS**, please have the following information available BEFORE contacting OMEGA:

1. Purchase Order number under which the product was PURCHASED,
2. Model and serial number of the product under warranty, and
3. Repair instructions and/or specific problems relative to the product.

FOR **NON-WARRANTY REPAIRS**, consult OMEGA for current repair charges. Have the following information available BEFORE contacting OMEGA:

1. Purchase Order number to cover the COST of the repair or calibration,
2. Model and serial number of the product, and
3. Repair instructions and/or specific problems relative to the product.

OMEGA's policy is to make running changes, not model changes, whenever an improvement is possible. This affords our customers the latest in technology and engineering.

OMEGA is a registered trademark of OMEGA ENGINEERING, INC.

© Copyright 2003 OMEGA ENGINEERING, INC. All rights reserved. This document may not be copied, photocopied, reproduced, translated, or reduced to any electronic medium or machine-readable form, in whole or in part, without the prior written consent of OMEGA ENGINEERING, INC.

# 5

3. Press the **LOCK** key to lock the trigger. The **LCK** icon will appear. This allows the thermometer to operate continuously whether or not the trigger is pulled. To unlock the trigger, press the **LOCK** key again.
4. To complete a temperature measurement, release the trigger; the thermometer goes into sleep mode.

**NOTE:** If the **LOBAT** icon flashes and the unit beeps intermittently, the batteries must be replaced with fresh batteries immediately.

While in these 5 modes:

Use **TEMP** key to change temperature from °F to °C or vice versa.

Use **BACKL** key to turn on the display backlighting.

It is the policy of OMEGA to comply with all worldwide safety and EMC/EMI regulations that apply. OMEGA is constantly pursuing certification of its products to the European New Approach Directives. OMEGA will add the CE mark to every appropriate device upon certification.

The information contained in this document is believed to be correct but OMEGA Engineering, Inc. accepts no liability for any errors it contains, and reserves the right to alter specifications without notice.

**WARNING:** These products are not designed for use in, and should not be used for, patient connected applications.

**PATENT NOTICE:** U.S. PAT. D357,194, B1 5,368,392, 5,524,984, 5,727,880, 5,465,838 5,823,678, 5,823,679, 6,267,500B1, 6,123,453, 6,341,891B1/Canada 75811© OMEGA ENGINEERING, INC., 2,116,055, 2,114,806/Czech Republic 25372/France 0378411 to 0378446, 2,767,921, 2 773 213 B1/Germany M 94 06 478.4, G 94 22 197.9, G 94 22 203.7/Italy RM940000913/Japan 988,378/ Netherlands 1007752, 25009-00/Spain mod. ut. 133292/Slovak Republic 24565/U.K. Registered 2041153, 9726133.3, EPO 0 644408, EP 1 085 307 A1 Other U.S. and International Patents Pending.

**CAUTION:** Use of controls or adjustments or performance of procedures other than those specified here may result in hazardous radiation exposure. Refer to the Operator's Manual for complete warnings and cautions.

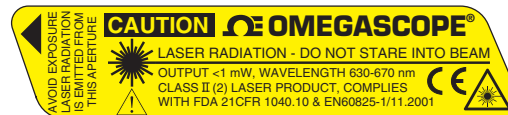

Warning and Certification Label

# 6

## VISUAL FUNCTION FLOW CHART

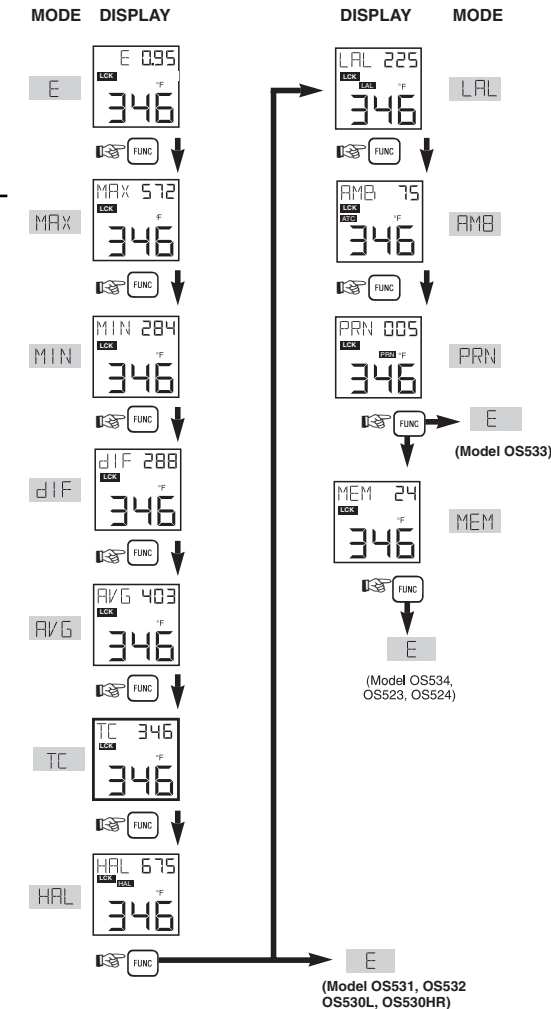

## QUICK START

**OS531**  
**OS532**  
**OS533**  
**OS534**  
**OS530L**  
**OS530HR**  
**OS53x-CF**  
**OS523**  
**OS524**

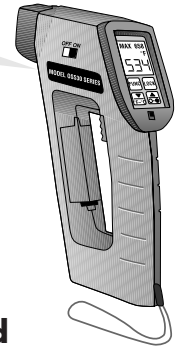

**OMEGASCOPE®**  
**Handheld Infrared**  
**Thermometer**

**omega.com®**  
Ω OMEGA®

<b>OMEGAnet® On-Line Service</b> www.omega.com	<b>Internet e-mail</b> info@omega.com
---	--

Servicing North America:	
<b>USA:</b> ISO 9001 Certified	One Omega Drive, P.O. Box 4047 Stamford CT 06907-0047 Tel: (203) 359-1660 e-mail: info@omega.com
<b>Canada:</b>	976 Bergar Laval (Quebec) H7L 5A1 Tel: (514) 856-6928 e-mail: info@omega.ca

For immediate technical or application assistance:	
<b>USA and Canada:</b>	Sales Service: 1-800-826-6342 / 1-800-TC-OMEGA® Customer Service: 1-800-622-2378 / 1-800-622-BEST® Engineering Service: 1-800-872-9436 / 1-800-USA-WHEN® TELEX: 996404 EASYLINK; 62968934 CABLE: OMEGA®
<b>Mexico:</b>	En Español: (001) 203-359-7803 FAX: (001) 203-359-7807 e-mail: espanol@omega.com info@omega.com.mx

Servicing Europe:	
<b>Benelux:</b>	Postbus 8034, 1180 LA Amstelveen, The Netherlands Tel: +31 (0)20 3472121 Toll Free in Benelux: 0800 0993344 e-mail: sales@omegaeng.nl
<b>Czech Republic:</b>	Frystavska 184, 733 01 Karviná 8, Czech Republic Tel: +420 (0)59 6311899 Toll Free: 0800-1-66342 e-mail: info@omegashop.cz
<b>France:</b>	11, rue Jacquess Cartier, 78280 Guyancourt, France Tel: +33 (0)1 61 37 29 00 Toll Free in France: 0800 466 342 e-mail: sales@omega.fr
<b>Germany/Austria:</b>	Daimlerstrasse 26, D-75392 Deckenpfronn, Germany Tel: +49 (0)7056 9398-0 Toll Free in Germany: 0800 639 7678 e-mail: info@omega.de
<b>United Kingdom:</b> ISO 9002 Certified	One Omega Drive, River Bend Technology Centre Northbank, Irlam, Manchester M44 5BD United Kingdom Tel: +44 (0)161 777 6611 Toll Free in United Kingdom: 0800-488-488 e-mail: sales@omega.co.uk

**START HERE**

**Using this Quick Start Manual**

Use this Quick Start Manual with your OS530/OS520 series Handheld Infrared Thermometer to set it up and perform basic operations. These tasks are:

- Installing the Batteries
- Operating the Laser Sight
- Taking Temperature Readings
- Display Mode Sequence

For detailed information, refer to the User's Guide (M2891).

**Getting Started**

**Parts of the Thermometer**

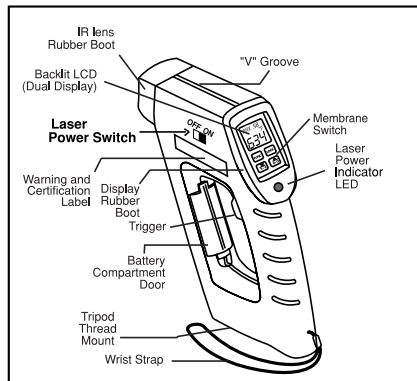

Figure 1. Front of the Thermometer

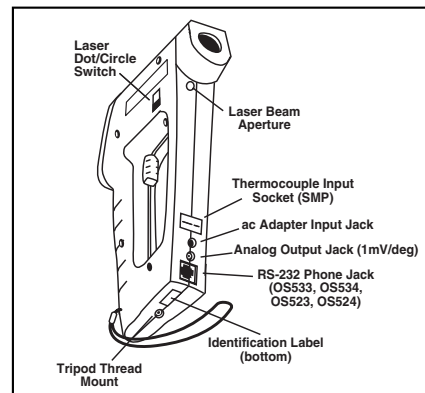

Figure 2. Rear of the Thermometer

**2**

**Parts of the Display**

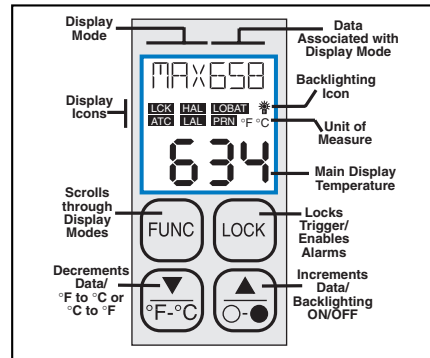

Figure 3. Display and Keypad View

**Installing the Batteries**

Invert the unit and install 4 fresh AA size batteries as shown in Figure 4.

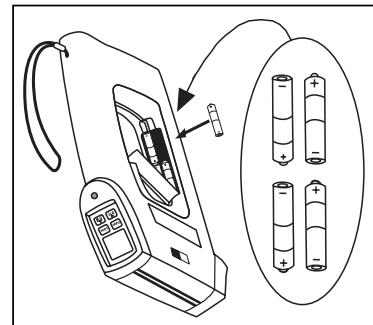

Figure 4. Installing the Batteries

**ac Operation**

The thermometer may be operated on ac power using the optional ac adapter. 120Vac/60 Hz and 220Vac/50 Hz adapters are available.

**Operating the Laser Sight Module**

**WARNING: DO NOT AIM THE LASER BEAM AT ANYONE'S EYES.**

The laser sight module is built into the thermometer. Set the laser power switch to the ON position.

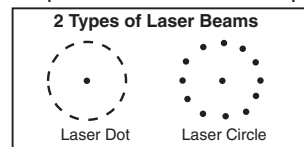

Figure 5. Two Laser Configurations

The thermometer is ready for operation.

**3**

**Taking Temperature Readings**

1. Aim at the target. If you are not using the Laser Sighting, use the "V" groove on top of the thermometer to align the target to the thermometer's field of view.

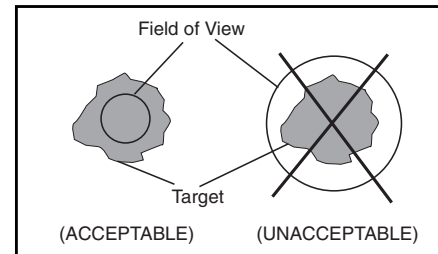

Figure 6. Field of View Positions

2. Pull and hold the trigger. To use the laser sighting, set the laser power switch to the ON position. The Power Indicator LED and the laser beam will turn on. The laser beam will stay on as long as the trigger is pulled. The target temperature and emissivity (E) will be displayed on the LCD. You can press the or key to increment or decrement the target emissivity.

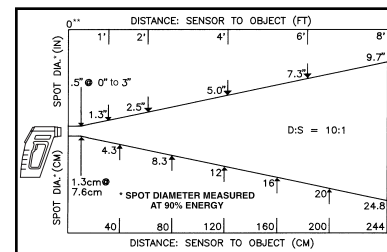

Figure 7. OS531, OS532, OS530L Field of View

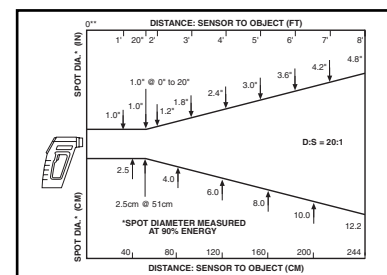

Figure 8. OS533, OS530HR Field of View

**4**

\*\* Measurement distance is from the outside surface of the rubber boot.

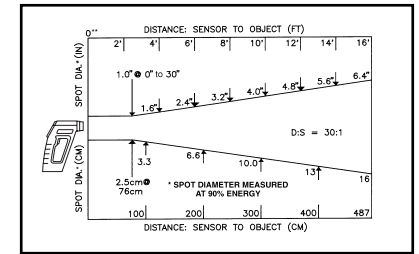

Figure 9. OS534/OS523-1 Field of View

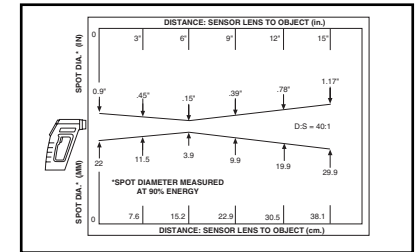

Figure 10. OS53x-CF Field of View

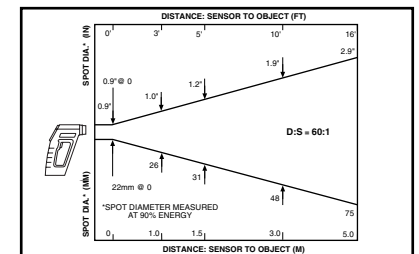

Figure 11. OS523-2 Field of View

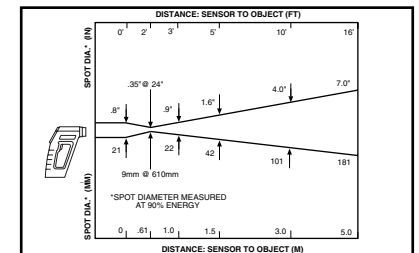

Figure 12. OS523-3 Field of View

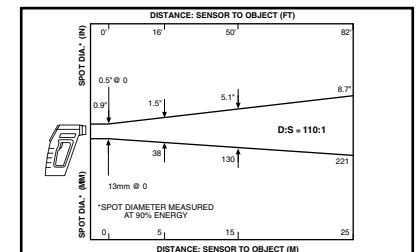

Figure 13. OS524 Field of View